



Russell Hobbs

Double Oven Instruction Manual



Model number(s):
RH89DEO2001B
RH89DEO2002SS

For Customer Services & Spare Parts please call **0345 208 8750**
or visit us at <https://mda.russellhobbs.com>

IMPORTANT:
RETAIN FOR FUTURE REFERENCE

Contents

Safety Instructions	3-5
Product Overview	6
Positioning	7
Installation	7-9
Electrical connection	10
Usage	11-24
Cleaning & Maintenance	25-30
Trouble shooting	31
Guarantee	32
Technical specification	33
Notes	34-35

Safety Instructions

Important note:

Please read this booklet before installing and switching on this appliance. The manufacturer assumes no responsibility for incorrect installation and usage as described in this booklet.

This appliance can be used by children aged from 8 years and above and persons with reduced physical, sensory or mental capabilities or lack of experience and knowledge if they have been given supervision or instruction concerning use of the appliance in a safe way and understand the hazards involved. Children shall not play with the appliance.

Electric ovens and hobs must be hard-wired to a suitably rated electrical cooker power point – it is recommended that you consult a qualified electrician. Failure to do so will invalidate your guarantee, liability claims and could lead to criminal prosecution

- Children should be supervised to ensure that they do not play with the appliance.
- If the supply lead is damaged it must be replaced by a qualified person using the correct lead, available from **0345 208 8750**.
- Packaging material is dangerous to children. Never allow children to play with packaging material.
- Check the appliance for damage after unpacking it. Do not connect the appliance if it has been damaged in transport.
- The appliance can only be used safely if it is correctly installed according to the safety instructions. The installer is responsible for ensuring that the appliance works correctly after installation.
- All operations relating to installation and regulation must be carried out by an authorised installation engineer, respecting applicable regulations, standards and the specifications of the local electricity providers.

Safety Instructions

- This appliance can only be installed in a well-ventilated place in accordance with existing regulations and ventilation specifications.
- This appliance is intended for domestic use and the household environment only. The appliance is not intended for use outside.
- Do not tamper with the appliance's interior. If necessary, call our customer helpline
- Do not switch on the appliance if it is damaged in any way. Contact our customer helpline
- This appliance is only intended for cooking purposes, not as a heating system.
- Do not leave the appliance unattended during operation. The manufacturer is not liable for damage which is caused by improper use or incorrect operation.
- Combustible items stored in the cooking compartment may catch fire. Never store combustible items in the cooking compartment. Never open the appliance door if there is smoke inside. Switch off the appliance and unplug it from the mains or switch off the circuit breaker in the fuse box.
- A draught is created when the appliance door is opened. Greaseproof paper may come into contact with the heating element and catch fire. Do not place greaseproof paper loosely over accessories during preheating. Always weight down the greaseproof paper with a dish or a baking tin. Only cover the surface required with greaseproof paper. Greaseproof paper must not protrude over the accessories.
- Always slide accessories into the cooking compartment
- The appliance becomes very hot. Never touch the interior surfaces of the cooking compartment or the heating elements. Always allow the appliance to cool down. Keep children at a safe distance.
- Accessories and ovenware become very hot. Always use oven gloves to remove accessories or ovenware from the cooking compartment.
- Shelves and the universal tray only must be placed and used between the 5 side supports.
- The universal tray or any other kind of baking tray should not be placed on the bottom of the oven cavity.

Safety Instructions

- Alcoholic vapours may catch fire in the hot cooking compartment. Never prepare food containing large quantities of drinks with a high alcohol content. Only use small quantities of drinks with a high alcohol content. Open the appliance door with care.
- The accessible parts become very hot when in operation. Never touch hot parts. Keep children at a safe distance.
- When you open the appliance door, hot steam may escape. Open the appliance door with care. Keep children at a safe distance.
- Water in a hot cooking compartment may create hot steam. Never pour water into the hot cooking compartment.
- Scratched glass in the appliance door may develop into a crack. Do not use a glass scraper, sharp or abrasive cleaning aids or detergents.
- The appliance gets hot. Do not keep combustible objects or aerosol cans in drawers directly underneath the appliance.
- A defective appliance may cause electric shock. Never switch on a defective appliance. Unplug the appliance from the mains or switch off the circuit breaker in the fuse box. Contact the customer services.
- The cable insulation on electrical appliances may melt when touching hot parts of the appliance. Never bring electrical appliance cables into contact with hot parts of the appliance.
- Penetrating moisture may cause an electric shock. Do not use any high pressure cleaners or steam cleaners.
- When replacing the cooking compartment bulb, the bulb socket contacts are live. Before replacing the bulb, unplug the appliance from the mains or switch off the circuit breaker in the fuse box.
- Incorrect repairs are dangerous. Repairs may only be carried out by a qualified electrician.
- Never use strong and abrasive cleaning agents as they will cause surface damage.
- In the event of a malfunction, turn off the appliance's electricity supply. For repairs, call customer services.
- Carrying the appliance: do not carry or hold the appliance by the door handle.

Product overview

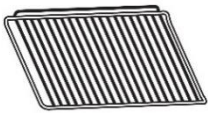
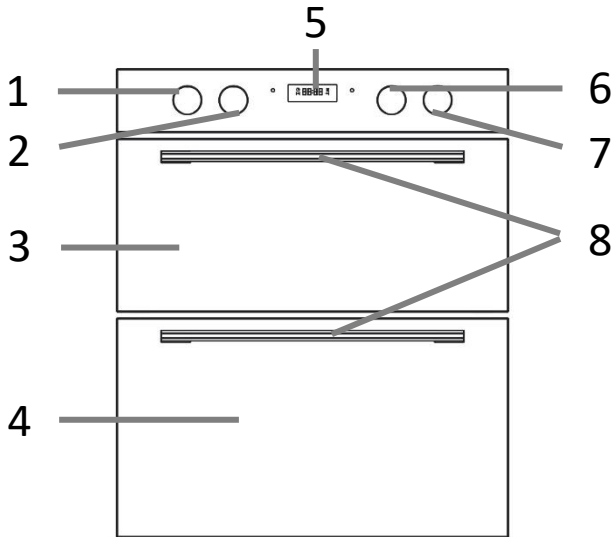

9



10



11



12

- | | |
|-------------------------------|---------------------------------|
| 1. Top oven function dial | 7. Bottom oven temperature dial |
| 2. Top oven temperature dial | 8. Oven door handles |
| 3. Top cavity glass window | 9. 2 x Wire shelf |
| 4. Bottom cavity glass window | 10. 1 x Universal tray & handle |
| 5. Display & mode buttons | 11. 1 x Wire rack |
| 6. Bottom oven function dial | 12. 2 x Distance holding screws |

Unit & Spare Parts

If any of the above parts are missing please contact the customer service team on 0345 208 8750 or visit <https://mda.russellhobbs.com>

Positioning

- This appliance is to be installed under a counter top.
- Avoid damaging the product during installation.
- The appliance can only be used safely if it is correctly installed according to the safety instructions. The installer is responsible for ensuring that the appliance works correct when installed.
- **Electric ovens and hobs must be hard-wired to a suitably rated electrical cooker power point – it is recommended that you consult a qualified electrician. Failure to do so will invalidate your guarantee, liability claims and could lead to criminal prosecution.**
- The aperture size has to be (H)885 x (W)563 x (D)550mm (please note that the depth size is a minimum measure, the oven can be installed in an aperture that has a bigger depth).

Installation without brackets (standard)

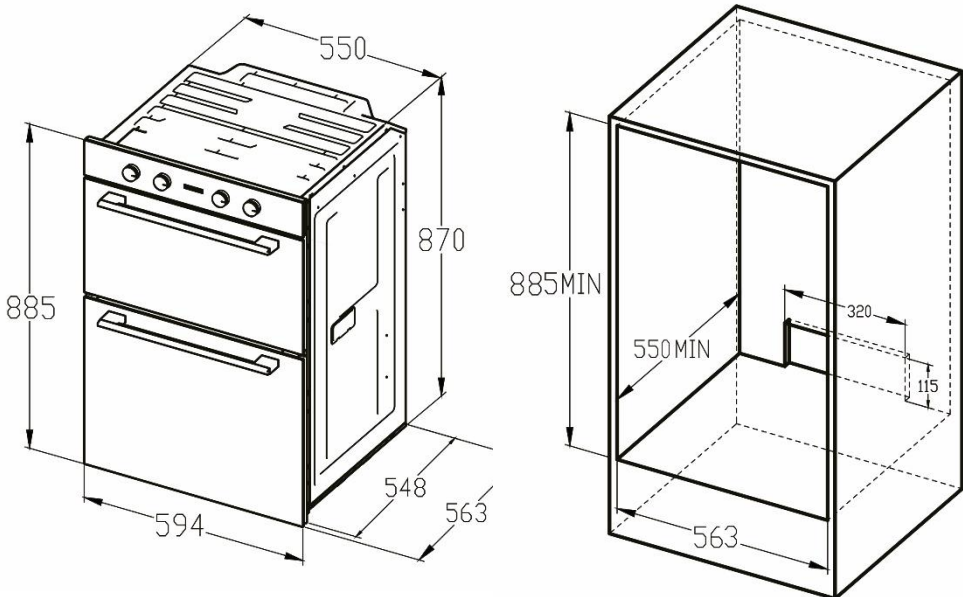

Installation with brackets

Note:

- Select heat-resistant work surface material to avoid larger deformation caused by the heat radiation from the appliance.
- This oven has forced air ventilation.
- If this appliance is to be installed near to a corner where the adjacent cabinets run at right angles forward of the appliance, there must be a gap of at least 90 mm between the appliance and the cabinets, to prevent overheating of the cabinets.

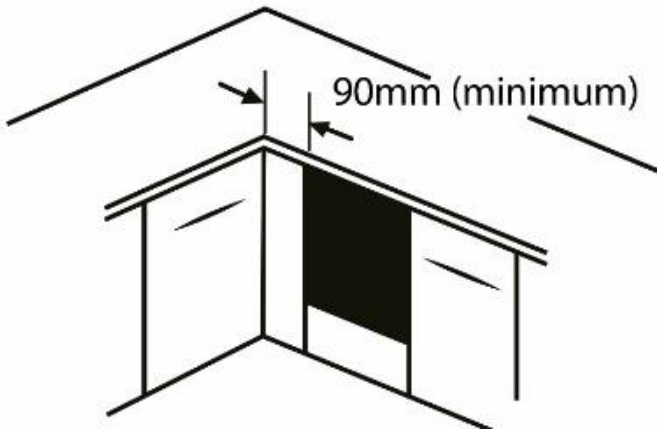

Installation

Ensure that there are no electric wires, gas or water pipes in the area where holes are to be made.

Components of the appliance may have sharp edges. Wear protective gloves.

1. Ensure that there is an electrical power point within adequate distance of the oven after it has been installed.
2. Ensure the aperture measures (H)885 x (W)563 x (D)550mm (please note that the depth size is a minimum measure, the oven can be installed in an aperture that has a bigger depth), in accordance with the positioning instructions detailed on the previous page.
3. Carefully and gently put the oven into the aperture recess, making sure that power cable can still be accessed.
4. Connect the oven to the electrical power point before pushing the oven into the aperture fully.
5. Once this is done open the oven door and secure the oven to the kitchen cabinet with two distance holding screws which fit the holes in the oven frame.

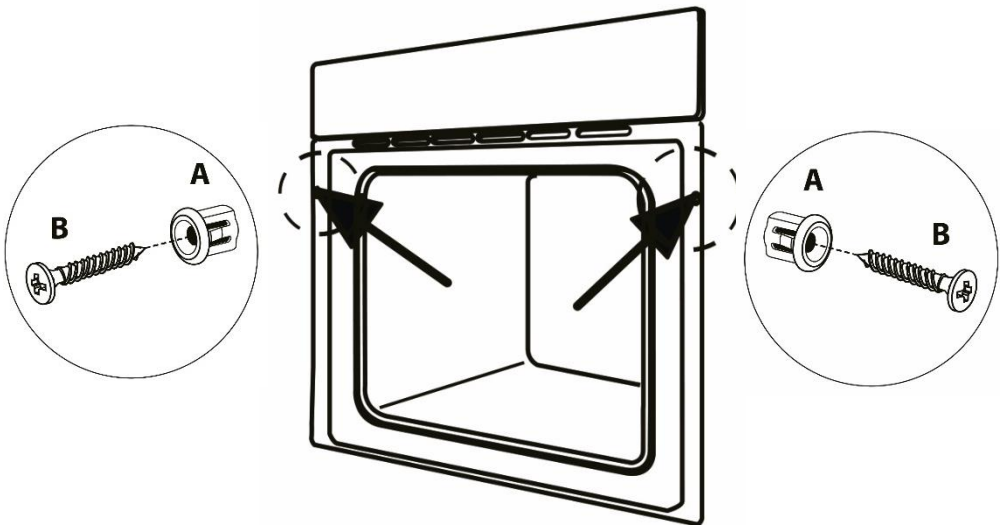

Electrical connection

- **WARNING- THIS APPLIANCE MUST BE EARTHED**
- This appliance is designed to be connected to a 220-240V~50Hz AC electricity supply.
- Before proceeding with the electrical connection, verify that the current carrying capacity of the system and the isolator / main switch is adequate for the maximum power rating of the oven.
- Electrical installation of the residence and of the appliance's isolator must be earthed and conform with the required safety regulations.
- If there is no suitable circuit and a fused switch, they must be installed by a qualified electrician before the hob is connected.
- An isolator switch must be easily accessible once the oven has been installed.
- Do not use adaptors, multiple sockets and/or extension leads.
- A circuit breaker with a contact opening of at least 3 mm, rated 32A and delayed functioning type must be installed inside the supply circuit.
- During installation, please ensure that insulated cables are used. An incorrect connection might damage your appliance and will void the manufacturer's guarantee.
- All repairs must be carried out by an authorised service personal or a qualified electrician.
- Switch off/isolate your appliance before each maintenance.
- The GREEN/YELLOW wire is the EARTH and must be connected to the terminal which is marked with the letter E or by the earth symbol or coloured GREEN or GREEN/YELLOW.
- The BLUE wire is the NEUTRAL and must be connected to the terminal marked with the letter N or coloured BLACK.
- The BROWN wire is the LIVE wire and must be connected to the terminal marked with the letter L or coloured RED.

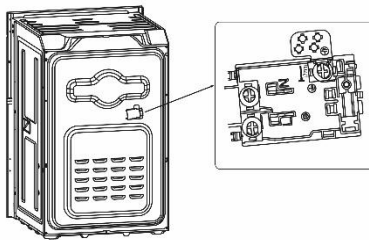

Usage

Control panel

The appliance has an oven function dial, temperature dial, a display and mode buttons, these are explained below:



Oven function dials

The oven function dials allow you to set the oven function mode for the top and/or bottom oven. The dial can be rotated clockwise or anti-clockwise to set the required oven function.



When the required type of function is set, the oven light(s) that are inside the ovens light up. The temperature dials will also need to be adjusted when using any of the oven functions except for the oven lamp functions.

Note: The dials must be put in the off position after each use.



Note: Always pre-heat the oven to the required temperature before cooking.

Top oven function dial

Symbol	Function
	Oven Lamp: Turns on the oven lamp.

Symbol	Function
	<p>Single grill: Part of the area below the grill heating element becomes hot. The inner grill element is on.</p> <p>Can be used to grill a small number of burgers, sausages fish or bread.</p>
	<p>Double grill: The whole area below the grill heating element becomes hot. The inner and outer grill elements are on.</p> <p>Can be used to grill a large number of burgers, sausages fish or bread.</p>
	<p>Top & bottom heating: Heat is emitted evenly from the top and bottom, which provides convectional cooking. The top and bottom elements work together to provide convectional cooking.</p> <p>Best suited for single items that are centred in the oven: cakes and pizzas on baking trays, and for lean joints of beef, etc.</p>

Bottom oven (main oven) function dial

Symbol	Function
	<p>Oven Lamp: Turns on the oven lamp.</p>
	<p>Defrost: Circulates air in the oven at room temperature (without the use of any heat) enabling quicker thawing of frozen food.</p> <p>Use to defrost food only.</p>
	<p>Convection heating: A fan with a ring heating element on the back of the oven ensures that the heated air is distributed evenly.</p> <p>You can bake cakes, pizza, biscuits, small cakes and puff pastry on two levels at the same time.</p>

Usage

Temperature dial

Use the temperature dials to set the required temperature for the ovens. The dials can then be rotated clockwise to set the required temperature.

The temperature can set between 50°C and 250°C.

The small light next to the temperature dial for the top oven will be lit when the top oven is heating and the small light next to the function dial for the bottom oven will be lit when the bottom oven is heating. It goes out during pauses in the heating.

The oven function dials will also need to be adjusted; turning the temperature dial alone will not make the oven heat up.

Note: The dial must be put in the off position after each use.

Display

This will show the time, icons and other values.

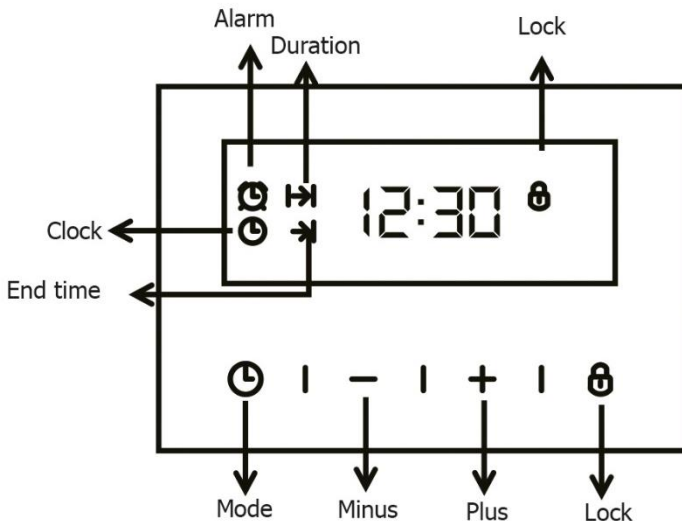

Usage

Function buttons

The buttons can be used to set additional functions.



Use this button to set the different modes



Use this button to adjust the setting values upwards. Press and hold the button to rapidly adjusted the time (hold for a minimum of 5 seconds).



Use this button to adjust the setting values downwards. Press and hold the button to rapidly adjusted the time (hold for a minimum of 5 seconds).



Use this button to set the lock function.

The oven cavity

- The oven lights are located in each cooking compartment. During oven operation, the oven lights are on. By turning the function selectors to any position, the oven lights can also be switched on without the oven heating up.
- A cooling fan protects the oven from overheating.
- The cooling fan switches on and off as required. The hot air escapes above the doors.
- So that the cooking compartment cools down more quickly after operation, the cooling fan continues to run for a certain period afterwards.
- There are shelf racks either side of the cavities that accessories such as the wire shelves, baking tray, etc. can be inserted in to.
- The coating of the oven cavities are enamel.
- Before you use the accessories for the first time, clean them with hot soapy water and a soft dish cloth.
- Clean all accessories by hand, do not clean in the dishwasher.

Usage

Warnings:

- **When it is first used, it is normal for the oven to give off odours; this does not pose any risk and does not indicate a malfunction; they will disappear in time.**

Note

- **The bottom oven cannot be operated unless the clock is set**



Setting the clock

When the oven is first connected to the electrical supply and powered on, the clock will need to be set. The display will show the time as "0:00" and will continually flash.

Note: ensure the correct time is set before using the oven.

Note: the clock is a 24 hour clock, for example 2PM will be shown as 14:00.

To set the correct time of day

1. Press the mode  button
2. Press "+" or "-" buttons to adjust the time. Press and hold the buttons to rapidly adjusted the time (hold for a minimum of 5 seconds).
3. Press the mode  button to confirm the time setting and the timer will be go in to standby mode.

Usage

Modes

It is recommended that you run the oven for 15 minutes at 200 degrees to burn off any residue from their surfaces on first use.

Note:

- **The cooking duration and full automatic programming modes can only be used for the bottom cavity.**



Time function setting

Press the mode  button to access the time function settings. These are:



1. Manual mode - the cooking time is controlled by the user. This mode can be used for the top and bottom cavities.

This mode is the default mode when the oven is taken out of standby. The cooking duration has to be controlled by the user (the oven will run continuously until turned off).

2. Minute minder - you can set an audible warning for a completed time period. This mode can be used for the top and bottom cavities.

Press the mode  button once and a  symbol will be shown on the display (the oven will not turn off when the time period has finished).

3. Cooking duration - you can set the oven so it will cook for a desired time range. This mode can only be used for the bottom oven cavity.

Press the mode  button 2 times and  will be shown on the display. The oven will automatically be turned off.

4. Fully automatic programming - cook during a desired time range to a desired time. This mode can only be used for the bottom oven cavity.

Please see page 20. The oven will automatically be turned off.

Usage



Manual mode

This mode can be used for the top and bottom cavities.

In manual mode, only the time will be shown on the display. The cooking duration has to be controlled by the user (the oven will run continuously until turned off).

To start cooking you need to **turn the oven function and temperature dials** that controls the top or bottom oven cavity to the required function and temperature. The oven light or lights will turn on and the oven will start to heat up. Once the oven is preheated, carefully put the food that you wish to cook into the oven.

Note: In manual mode, if after 5 hours no button has been pressed the display on the oven will flash to warn you that it will turn off and automatically enter standby mode. After 10 hours the oven will automatically turn off and enter the standby mode. When the display is flashing in manual mode, press any button to continue using the oven. If you don't want to continue using the oven then turn the oven function and temperature dials to the off position.







Note: If you set cooking duration  mode or fully automatic programming mode  , then after cooking the oven will automatically turn off and enter the standby mode.



Usage

Minute minder (audible warning)

This mode can be used for the top and bottom cavities.

This function can be used to set an audible warning at the completion of the adjusted time period. Like the manual mode the cooking duration has to be controlled by the user (the oven will run continuously until turned off). To start cooking you need to **turn the oven function and temperature dials** that controls the top or bottom oven cavity to the required function and temperature. The oven light will turn on and the oven will start to heat up. Once the oven is preheated, carefully put the food that you wish to cook into the oven:

1. To set the minute minder press the mode  button once, the  symbol will then light up on the display and start to flash.
2. Press the "+" or "-" button to adjust the time. Press and hold the buttons to rapidly adjusted the time (hold for a minimum of 5 seconds). The  symbol will continue to flash.
3. Once the required time has been reached, do not press any button and the time will be confirmed. The  symbol will stop flashing and stay lit. The display will revert to clock time while the minute minder time counts down.
4. When the time is up, the timer will beep and the  symbol will flash on the display. Press any button to stop the beeping and the  symbol flashing. The display will revert back to the clock/time.
5. The oven will continue to operate unless the oven function or temperature dials are turned to the off position.











To cancel the minute minder press the mode  button once, the  symbol will then light up and set time will be shown. Press the "-" button to adjust the time to 0. The minute minder mode will be cancelled.

Usage

Cooking duration (cook for a desired time period)

This mode can only be used for the bottom cavity.

This function is used to cook for a desired time range (the maximum cooking period is 23 hours and 59 minutes). To start cooking you need to **turn the oven function and temperature dials** to the required function and temperature. The food that is to be cooked needs to be put into the oven.

1. To set this mode, press the mode  button twice and the  symbol will be lit on the display and start to flash.
2. Press the "+" or "-" button to adjust the cooking duration time. Press and hold the buttons to rapidly adjusted the time (hold for a minimum of 5 seconds). The  symbol will continue to flash.
3. Once the required time has been reached, do not press any button and the time will be confirmed. The  symbol will stop flashing and stay lit. The display will revert to clock time while the cooking duration time counts down.
4. During the cooking duration, press the mode  button to check and change the cooking time.
5. To cancel the cooking duration press the mode  button twice, the  symbol will then light up and set time will be shown. Press the "-" button to adjust the time to 0. The cooking duration mode will be cancelled.
6. When the cooking time has been reached, the oven will beep, the  symbol will flash on the display, '0:00' will be shown on the display and the oven will automatically be turned off. Press the mode  button to stop the beeping and press it again to stop the  symbol flashing.
7. The timer will enter manual mode, if you don't wish to continue cooking then turn the oven function and temperature dials to the off position.











Usage

Fully automatic programming (cook during a desired time range to a desired time)



This mode can only be used for the bottom cavity.

This function is used to cook after a certain period of time, with a certain duration. To start cooking you need to **turn the oven function and temperature dials** to the required function and temperature.

The oven will start operating at the time calculated by deducting the cooking period from the set finishing time, and will stop at the set finishing time. For example if the current time is 13:00, the required cooking time is 1 hour and the required cooking end time is 18:00. The oven will start to operate 17:00 and end at 18:00.

1. To set this mode, press the mode  button twice and the  symbol will be lit on the display and start to flash.
2. Press the "+" or "-" button to adjust the cooking duration time. Press and hold the buttons to rapidly adjusted the time (hold for a minimum of 5 seconds). The  symbol will continue to flash.
3. Once the required cooking duration time has been reached, press  mode button and the  symbol will be lit on the display and will start to flash.
4. Press the "+" or "-" button to set the cooking end time. Press and hold the buttons to rapidly adjusted the time (hold for a minimum of 5 seconds). The symbol will continue to flash.
5. Once the required cooking end time has been reached, do not press any button and the time will be confirmed. The  symbol will stop flashing and both the  and  symbols will stay lit. The display will revert to clock time.
6. To cancel the fully automatic programming press the mode  button twice, the  symbol will then light up and set time will be shown. Press the "-" button to adjust the time to 0. The fully automatic programming mode will be cancelled.
7. When the calculated cooking start time is reached, the oven will start to operate and only the  symbol will be lit on the display.

Usage

8. When the cooking end time has been reached, the oven will beep, the  symbol will flash on the display, '0:00' will be shown on the display and the oven will automatically be turned off. Press the mode  button to stop the beeping and press it again to stop the  symbol flashing.
9. The timer will enter manual mode, if you don't wish to continue cooking then turn the oven function and temperature dials to the off position.

Note:

- When cooking end time is longer than the cooking duration time plus the current time, then the cooking end time can be decreased by pressing the "-" button. It can be decreased until the cooking end time equal the cooking duration time plus the cooking time plus 1 minute).
- **For example if the current time is 13:00, the required cooking time is 1 hour and the required cooking end time is 18:00. You can decrease the cooking end time to 14:01**
- When cooking end time is equal to the cooking duration time plus the current time, then the cooking end time can only be increased by pressing the "+" button. It can be increased by a maximum 23 hours and 59 minutes.
- **For example if the current time is 13:00, the required cooking time is 1 hour and the required cooking end time is 14:01. You can increase the cooking end time from 14:01 to 13:59 the next day.**
- If cooking end time is longer than the cooking duration time plus the current time, then the oven will power off and the display will enter the standby mode (the current time will be shown). When cooking end time is equal to the cooking duration time plus the current time, the oven will power on again, and the cooking end time icon will turn off.

Usage

Lock Function

Press the lock button for a minimum of 3 seconds, the lock function will be activated and the lock symbol will be lit on the display. When the lock function is activated, no modes can be accessed or the clock adjusted. The oven function dials and temperature dials can still be adjusted. If any button is pressed when the lock function is active then the lock symbol on the display will flash and there will be a beep.

To deactivate the lock function press the lock button for 3 seconds, the symbol will disappear from the display.

Tips

- Press the "+" or "-" buttons for more than 5 seconds to make the time rapidly increase or decrease.
- To cancel any mode adjust the time that has been set to 0.

Energy saving

The following advice is to help you save energy:

- Only preheat the oven if this is specified in the recipe
- Open the oven door as infrequently as possible
- Use black enamelled baking trays, tins, etc. as they absorb the heat well.
- If you need to cook, bake or roast a number of different foods then it is best to do this one after the other. The oven will be at temperature, reducing the need to pre-heat the oven again.
- Cook more than 1 item at a time using the different accessories provided.

Usage

Accessories

Warning:

- **Correct placement of the shelves between the side racks is imperative. This will ensure that food does not fall off or slide out when in the oven or being carefully removed from the oven.**
- **Ensure that you always insert the accessories into the cooking compartment the right way round.**
- **Shelves and the universal tray only must be placed and used between the 5 side supports.**
- **The universal tray or any other kind of baking tray should not be placed on the bottom of the oven cavity.**

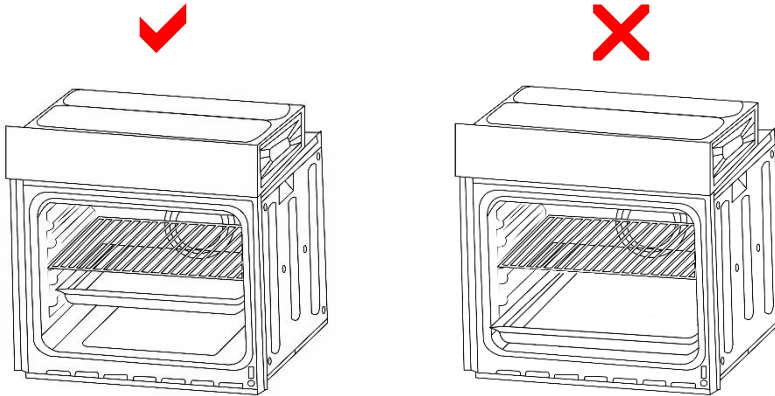

The accessories can be inserted in the oven at 5 different levels. Always insert the accessories as far as they can go to ensure that they do not touch the door glass.

Wire shelf - for ovenware, cake tins, roasts, grilling and frozen meals. Slide the wire rack into the oven with the raised part at the back and at the top.

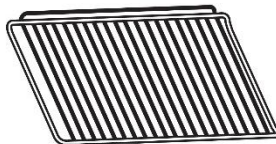

Usage

Universal tray - for cooking large quantities of food such as cakes, pastries, frozen food, etc. Can also be used under the wire rack to catch fat when grilling. Slide the baking tray into the oven with the sloping edge facing towards the oven door.

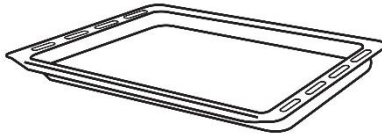

Wire rack - for grilling and roasting. Place the wire insert in the universal tray with the legs facing downwards. This ensures that dripping fat and meat juices are collected.



:

Cleaning and Maintenance:

Important notes:

- The appliance will become hot during operation, allow the appliance to cool down before cleaning.
- Do not use any high-pressure cleaners or steam cleaners.
- Wash new sponge cloths thoroughly before use.
- Do not leave acidic substances (lemon juice, vinegar) on stainless steel parts.
- Follow all instructions and warnings included with the cleaning agents.

How to clean

Observe the information in the table below to ensure that the different surfaces are not damaged by using the wrong type of cleaning agent. **Do not use:**

- Harsh or abrasive cleaning agents,
- Cleaning agents with a high concentration of alcohol,
- Hard scouring pads or sponges,
- High-pressure cleaners or steam cleaners.
- Clean all accessories by hand, do not clean in the dishwasher.

Surface type	How to clean
Stainless Steel	Hot soapy water: Clean with a dish cloth and dry with a soft cloth. Clean stainless steel surfaces in the direction of the grain only. Special stainless steel cleaning products are available from specialist retailers. Apply a very thin layer of the cleaning product with a soft cloth.
Painted surfaces	Hot soapy water: Clean using a damp dish cloth and dry with a soft cloth/towel. Do not use any stainless steel cleaners.
Aluminium and plastic	Glass cleaner: Clean with a soft cloth.
Glass	Glass cleaner: Clean with a soft cloth. Do not use a glass scraper.
Enamel	Clean with some washing-up liquid and a damp cloth. Dry with a soft cloth.

Cleaning and Maintenance:

- After each use, clean all surfaces once they have cooled down. If any residue is left (baked-on food, drops of grease etc.), however little, will become stuck to the surface and more difficult to remove later.
- Always clean off any liquid as soon as it is spilt: you will save yourself any unnecessary effort.
- Where possible, do not allow salt to come into contact with the surfaces of the appliance.

Shelf racks

- The shelf racks inside the cavities can be removed to enable you to clean them thoroughly.
- Make sure they are cool to touch and then grasp the racks and slide out of their hanging holes.

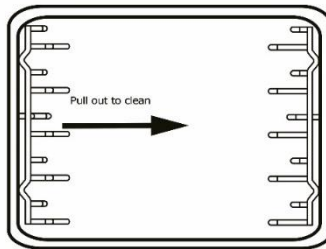

Removing the door & Glass door window

- To remove the door, open the door to the maximum angle. Then pull the buckle at the door hinge backward.



Cleaning and Maintenance:

- The inner door glass panel can be removed for cleaning. Note that it must be replaced the right way up so care must be taken when removing it. To remove the glass panel, open the door wide, push the clips on the left and right sides of door bracket. Then remove the plastic top cover.

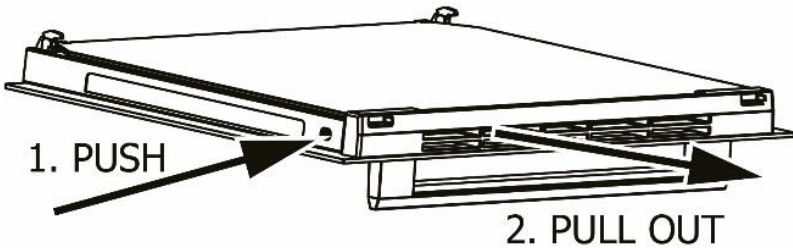

- Hold the glass and slide it out along the door bracket.

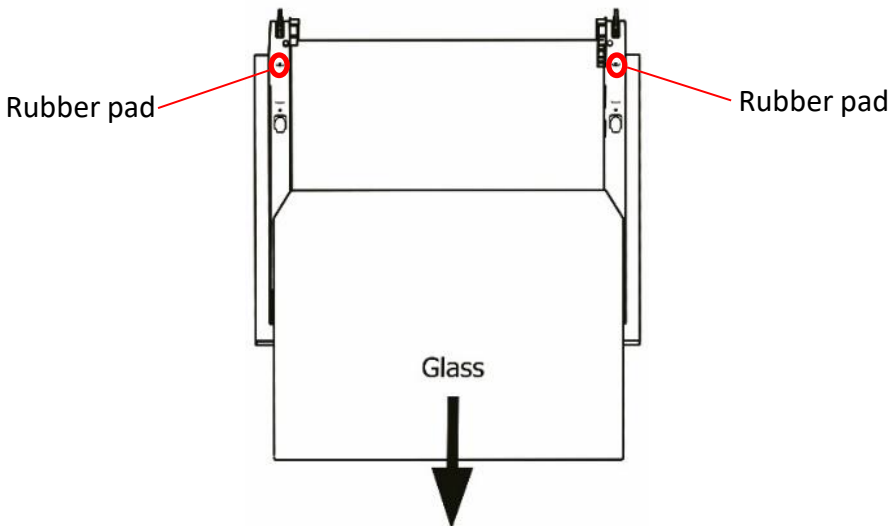

Cleaning and Maintenance:

- To reinstall the glass reverse the above steps after cleaning the glass (you must ensure the glass is fully dry) always make sure that the glass is the right way up and is pushed fully into position. When reinstalling the inner glass panel care must be taken not to push out the 2 rubber pads that are near the bottom of the inner door.
- Close the door to an angle approximately 30°. Hold the door with one hand on each side. Lift up and slowly pull the door out from the oven.

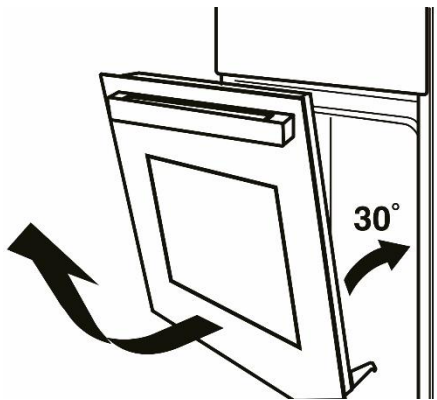

Warning:

- Do not operate the appliance without the glass panel correctly fitted.
- The glass door panels are made of toughened glass. This ensures that, in the unlikely event that a panel breaks, it does so into small fragments to minimise the risk of injury. Please take care when handling, using or cleaning all glass panels, as any damage to the surfaces or edges may result in the glass breaking without warning or apparent cause at a later date. Should any glass panel be damaged, we strongly recommend that it is replaced immediately.

Cleaning and Maintenance:

Causes of damage:

- **Accessories, foil, greaseproof paper or ovenware on the cooking compartment floor:** Do not place accessories on the cooking compartment floor. Do not cover the cooking compartment floor with any sort of foil or greaseproof paper. Do not place ovenware on the cooking compartment floor if a temperature of over 50°C has been set. This will cause heat to accumulate. The baking and roasting times will no longer be correct and the enamel will be damaged.
- **Water in a hot cooking compartment:** Do not pour water into the cooking compartment when it is hot. This will cause steam. The temperature change can cause damage to the enamel.
- **Moist food:** Do not store moist food in the cooking compartment when it is closed for prolonged periods. This will damage the enamel.
- **Fruit juice:** When baking particularly juicy fruit pies, do not pack the baking tray too generously. Fruit juice dripping from the baking tray leaves stains that cannot be removed. If possible, use the deeper universal pan.
- **Cooling with the appliance door open:** Only allow the cooking compartment to cool when it is closed. Even if the appliance door is only open a little, front panels of adjacent units could be damaged over time.

Cleaning and Maintenance:

- **Very dirty door seal:** If the door seal is very dirty, the appliance door will no longer close properly when the appliance is in use. The fronts of adjacent units could be damaged. Always keep the door seal clean.
- **Never use the appliance door as a seat, shelf or worktop:** Do not sit on the appliance door, or place or hang anything on it. Do not place any cookware or accessories on the appliance door.
- **Inserting accessories:** accessories can scratch the door panel when closing the appliance door. Always insert the accessories into the cooking compartment as far as they will go.

Changing the bulb

If the bulb in the oven light fails, it must be replaced with a heat resistant 25 watt bulbs only. To replace the bulb follow the below steps:

Note: the oven lamp is located at the top right on the back of the oven.

1. Switch off the circuit breaker of the unit's mains outlet or fuse box.
2. Place a tea towel in the oven when it is cold to prevent damage.
3. Unscrew the glass cover by turning it anti-clockwise.
4. Replace the bulb with one of the same type.
5. Screw the glass cover back in.
6. Remove the tea towel and switch on the circuit breaker.

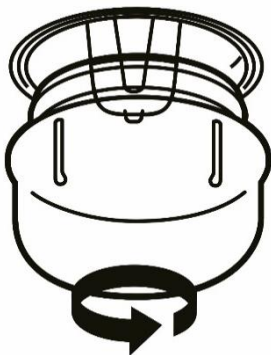

 Russell Hobbs

Trouble Shooting:

Problem	Solution
No power	<p>The circuit break is defective or turned off</p> <p>check circuit breaker is in working order and that it is not switched off</p>
	<p>Power cut or faulty fuse</p> <p>Check whether other kitchen appliances are working or check in the fuse box to make sure that the fuse for the appliance is working</p>
Functions are none responsive when turning the dials	<p>The oven doesn't heat up</p> <p>Check the oven function and temperature dials have both been set</p>
	<p>The oven doesn't heat up</p> <p>Turn the control dials several times, as there may be dust between the connections</p>
The clock flashes	<p>There has been a power cut</p> <p>Reset the clock</p>
Food is being burnt	<p>Location of the shelves are incorrect or the cooking function that has been selected is incorrect</p> <p>Adjust the shelf locations and/or the cooking function that is being used</p>

Guarantee

This product is guaranteed for 12 months from the date of the original purchase. If any defect arises due to faulty materials or workmanship you must contact Russell Hobbs with the original proof of purchase so a replacement or refund can be arranged.

Refund or replacement is at the discretion of Russell Hobbs.

The following conditions apply:

- Russell Hobbs will require a valid proof of purchase at the point of replacement or refund.
- The product must be installed and used in accordance with the instructions contained in this instruction guide and any other instructions for use which has been supplied.
- It must be used for domestic purposes only and for its intended use.
- This guarantee does not cover wear and tear, damage, misuse or consumable parts.

This does not affect your statutory rights.

Imported by
G2S LIMITED
WIGAN
WN2 4AY

Technical Specification

Model number	RH89DEO2001B RH89DEO2002SS
Rated Voltage	220V – 240V ~ 50Hz
External Dimensions (HxWxD) including handle	885mm x 594mm x 575mm
External Dimensions (HxWxD) excluding handle	885mm x 594mm x 563mm

Notes

Notes

For Customer Services & Spare
Parts please call **0345 208 8750**
or visit us at
<https://mda.russellhobbs.com>



This symbol is known as the 'Crossed-out wheeie bin Symbol'. When this symbol is marked on a product/batteries, it means that the product/batteries should not be disposed of with your general household waste. Only discard electrical/electronic/battery items in separate collection schemes, which cater for the recovery and recycling of materials contained within. Your co-operation is vital to make sure the success of these schemes and for the protection of the environment. For your nearest disposal facility, visit www.recycle-more.co.uk or ask in store for details.

We reserve the right due to possible changes to design to alter the instruction manual without prior notice.

 **Russell Hobbs**

Revision 3